

Kostenvoranschlag **Bestellung**

Sitzschalenfahrgestell Calimero

Adresse (Firmenstempel)	Patientengewicht (ca.) <div style="text-align: center; font-size: 2em;">kg</div> <hr style="border-top: 1px dotted black;"/> <div style="text-align: center; font-size: 2em;">cm</div>	Kommission:
	Patientengröße (ca.)	Besteller: Datum:

Hilfsmittelnummern: 26.99.01.3028

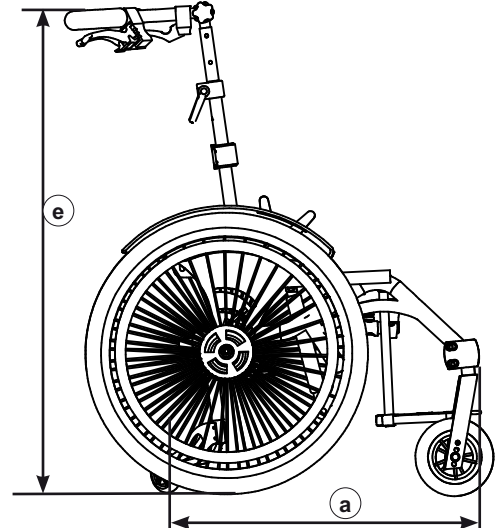
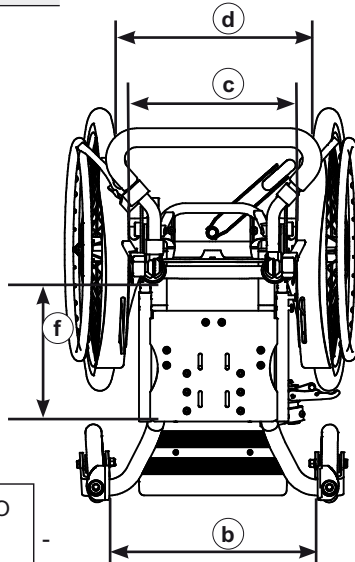
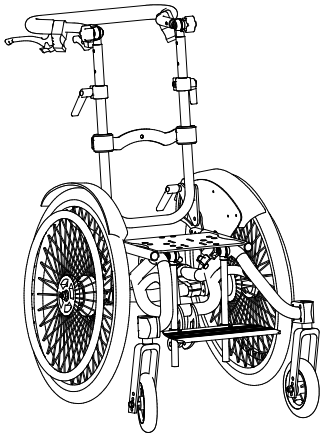

Dieses Sitzschalenfahrgestell ist nach ISO 7176-19 geprüft und als Sitz für den Transport in Kraftfahrzeugen freigegeben (mit Kraftknotensystem).



Gr.	Sitzhöhe minimal	Maß a Rahmenlänge	Maß b Rahmenbreite, innen	Maß c Rahmenbreite	Maß d Breite zwischen Antriebsrad	Maß e Rückenhöhe	Maß f Sitziefe
0	41 cm bei 20"	55 cm	42 cm	31 cm	35cm oder 38cm	88cm	25cm-33cm
1	41 cm bei 20"	55 cm	42 cm	34 cm	38cm oder 41cm	88cm	25cm-33cm

Gewicht und Zuladung	Radstands- verlängerung	Antriebsräder Trommelbremse	Kippwinkel	Radsturz / Breite zwisch. Antriebsrad	Bremsgriffe
Je nach Ausstattung ab 13kg max. Patientengewicht inkl. Sitzschale: 75kg* * größere Zuladung wegen der klei- nen Bauart nicht möglich	stufenlos 10 cm im Innenrahmen integriert Sitztiefenverstellung verschraubt 6cm	project: 20" 22"	30°	0° <input type="checkbox"/> Gr. 0- 38 cm <input type="checkbox"/> Gr. 1 5° <input type="checkbox"/> Gr. 0- 35 cm <input type="checkbox"/> Gr. 1- 38 cm	rastend <input type="checkbox"/> Ja <input type="checkbox"/> Nein
			Rückenwinkel		
			40°		

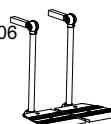

Farbe Gestell (bitte wählen)	Rückenverstellung: <small>Norm</small> Manuell status modification date name
<input type="checkbox"/> Reinweiß (RAL 9010) <input type="checkbox"/> Zinkgelb (RAL 1018) <input type="checkbox"/> Erikaviolett (RAL 4003) <input type="checkbox"/> Signalviolett (RAL 4008) <input type="checkbox"/> Verkehrsblau metallic (RAL 5017) <input type="checkbox"/> Tiefschwarz (RAL 9005)	

Farbwunsch auf Anfrage:

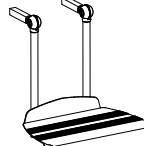
Sitzschalenfahrgestell Calimero

Calimero Antriebsrad mit Trommelbremse <input type="checkbox"/> Gr. 0 (Code 370 000) <input type="checkbox"/> Gr. 1 (Code 371 000)	Fußbank komplett Code 370 005  (Kniewinkel verstellbar, Fußwinkel fest inkl. Aufnahme Code 370004)	Fußbank komplett, geteilt Code 370 006  (Kniewinkel verstellbar, Fußwinkel fest inkl. Aufnahme Code 370004)	Fußwinkel verstellbar Code 370 008 	Fersenkante Code 370 007 
Grundpreis 2044,- €	<input type="checkbox"/> Stück 264,- €	<input type="checkbox"/> Paar 327,- €	<input type="checkbox"/> MP 99,- €	<input type="checkbox"/> MP 88,- €

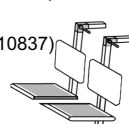
Trapezadapter, komplett <input type="checkbox"/> für Gr. 0 und 1 (Code 370)	Trapezadapter, Unterteil <input type="checkbox"/> für Gr. 0 und 1 (Code 37001)	Fußbankaufnahme an Sitzplatte (für separate Fußbank) Code 370 004 <input type="checkbox"/> Satz 87,- €	Wadenpolster, durchgehend  <input type="checkbox"/> 19x11cm (Code 1010799) <input type="checkbox"/> 22x11cm (Code 1010800) <input type="checkbox"/> 27x16cm (Code 1010801) <input type="checkbox"/> 30x16cm (Code 1010802) <input type="checkbox"/> 33x16cm (Code 1010803) <input type="checkbox"/> 36x16cm (Code 1010804) <input type="checkbox"/> 39x16cm (Code 1010805)
<input type="checkbox"/> Satz 349,- €	<input type="checkbox"/> Stück 183,- €	<input type="checkbox"/> Satz 87,- €	<input type="checkbox"/> Stück 161,- €

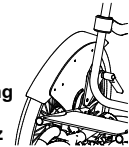
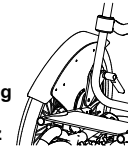
Wadenpolster, geteilt <input type="checkbox"/> 14,5x11cm (Code 1010835) <input type="checkbox"/> 16x11cm (Code 1010837) 	Antriebsrad mit Trommelbremse, mit Bedienung für Begleitperson  <input type="checkbox"/> 20" <input type="checkbox"/> 22"	Antriebsrad, pannensichere Bereifung - ohne MP „optional“ Code 370 013 <input type="checkbox"/> OPTIONAL	Radschutz, Ausführung ohne Feststellbremse Code 370 009  <input type="checkbox"/> Carbon Nachbildung <input type="checkbox"/> Schwarz	Radschutz, Ausführung für Feststellbremse Code 370 010  <input type="checkbox"/> Carbon Nachbildung <input type="checkbox"/> Schwarz
<input type="checkbox"/> Stück 202,- €	<input type="checkbox"/> STANDARD	<input type="checkbox"/> OPTIONAL	<input type="checkbox"/> Paar 233,- €	<input type="checkbox"/> Paar 254,- €

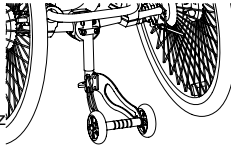
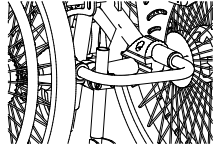
Lenkrad <input type="checkbox"/> 5" Vollgummi <input type="checkbox"/> 6" Vollgummi <input type="checkbox"/> 6" luftbereift <input type="checkbox"/> 7" luftbereift <input type="checkbox"/> 7" Vollgummi	Feststellbremse am Antriebsrad Code 370 002 nur in Verbindung mit Radschutz und Luftbereifung	Kippsicherung Code 370 011 	Ankippbügel Code 370 012 	Kraftknotensystem (zur Befestigung des Sitzschalenfahrgestells für den Transport in Fahrzeugen) Code 370 003
<input type="checkbox"/> STANDARD	<input type="checkbox"/> Stück 199,- €	<input type="checkbox"/> Stück 164,- €	<input type="checkbox"/> Stück 73,- €	<input type="checkbox"/> Satz 476,- €

Speichenschutz transparent: <input type="checkbox"/> 20" - Code 364 <input type="checkbox"/> 22" - Code 365 orange: <input type="checkbox"/> 22" - Code 365-2 blau: <input type="checkbox"/> 22" - Code 365-1 	anatomisches Sitz- und Rückensystem 	anatomischer Sitz Code 60040 	anatomischer Rücken Code 60041 	Seitenführungspelotten Code 60042 
<input type="checkbox"/> Paar 179,- €	<input type="checkbox"/> Stück 569,- €	<input type="checkbox"/> Stück 419,- €	<input type="checkbox"/> Stück 419,- €	<input type="checkbox"/> Paar 316,- €

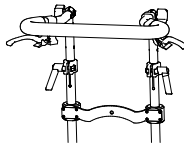
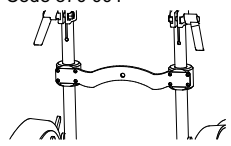
Schiebebogen, winkelverstellbar 	Rückenbefestigung für Sitzschale Code 370 001 	Sitzmaße Größe 0 SB <input type="checkbox"/> <input type="checkbox"/> <input type="checkbox"/> <input type="checkbox"/> <input type="checkbox"/> <input type="checkbox"/> 20 22 24 26 28 30 ST <input type="checkbox"/> <input type="checkbox"/> <input type="checkbox"/> <input type="checkbox"/> <input type="checkbox"/> <input type="checkbox"/> 20 22 24 26 28 30 RH <input type="checkbox"/> <input type="checkbox"/> 25 30	Sitzmaße Größe 1 SB <input type="checkbox"/> <input type="checkbox"/> <input type="checkbox"/> <input type="checkbox"/> <input type="checkbox"/> <input type="checkbox"/> 30 32 34 36 38 40 ST <input type="checkbox"/> <input type="checkbox"/> <input type="checkbox"/> <input type="checkbox"/> <input type="checkbox"/> <input type="checkbox"/> 28 30 32 34 36 38 RH <input type="checkbox"/> <input type="checkbox"/> 35 40 Achtung!: SB 38 und 40 geht nur ohne Sturz!	Bezugsfarben: <input type="checkbox"/> orange <input type="checkbox"/> hellrot <input type="checkbox"/> dunkelrot <input type="checkbox"/> blau <input type="checkbox"/> schwarz <input type="checkbox"/> graphit <input type="checkbox"/> hellgrün
<input type="checkbox"/> STANDARD	<input type="checkbox"/> Stück 224,- €			

Sitzsystem Calimero

	Grundausrüstung: • Basis-Sitzeinheit inkl. Polsterung • Beckenpelotten • Sitz breiten- u. tiefenverstellbar • Rücken breiten- u. höhenverstellbar • Sitztiefenverstellung • Adduktionsführung verstellbar nach links und rechts • Bezugfarbe: schwarz	Calimero Sitzsystem Gr. 1 montiert Größe 0: Code 600001 C SB: 18-25 cm ST: Sitzpolster kurz 18-26 cm ST: Sitzpolster lang 24-34 cm RH: 30-45 cm Achtung: Preis nur für Sitzsystem	Calimero Sitzsystem Gr. 2 montiert Größe 1: Code 600002 C SB: 21-28 cm ST: Sitzpolster kurz 25-33 cm ST: Sitzpolster lang 31-38 cm RH: 40-50 cm Polster: 33 cm/ 38 cm Achtung: Preis nur für Sitzsystem	Calimero Sitzsystem Größe 1 / Gr. 2: SB: ST: RH:
	<input type="checkbox"/> Stück 1.749,- €	<input type="checkbox"/> Stück 1801,- €		

Abschwenkbare Seitenführungspelotte Code 60020 C <input type="checkbox"/> rechts <input type="checkbox"/> links <input type="checkbox"/> Stück MP 176,- €	Seitenführungspelotte fest Code 60019 C <input type="checkbox"/> rechts <input type="checkbox"/> links <input type="checkbox"/> Stück 114,- €	Sitzkeile Code 60031 C <input type="checkbox"/> Paar 57,- €	Lordosenstütze Code 60029 C Maß a = _____ cm Maß b = _____ cm Maß c = _____ cm <input type="checkbox"/> Stück 42,- €
--	--	--	--

Spinenpelotten Code 61015 C <input type="checkbox"/> Größe 1 <input type="checkbox"/> Größe 2 <input type="checkbox"/> Größe 3 <input type="checkbox"/> Größe 4 Bitte wählen! <input type="checkbox"/> Stück 192,- €	Spina-Maße: A = max. Breite B = min. Breite <table border="1" style="width: 100%; text-align: center;"> <thead> <tr> <th></th> <th>A</th> <th>B</th> </tr> </thead> <tbody> <tr> <td>Gr.1</td> <td>19,5</td> <td>13,5</td> </tr> <tr> <td>Gr.2</td> <td>26,5</td> <td>19,5</td> </tr> <tr> <td>Gr.3</td> <td>32,5</td> <td>29,5</td> </tr> <tr> <td>Gr.4</td> <td>38</td> <td>32</td> </tr> </tbody> </table>		A	B	Gr.1	19,5	13,5	Gr.2	26,5	19,5	Gr.3	32,5	29,5	Gr.4	38	32	Rückenverlängerung Code 60028 C <input type="checkbox"/> Bei Gr.1 um 6 cm <input type="checkbox"/> Bei Gr.2 um 7 cm <input type="checkbox"/> Bei Gr.3 um 8 cm <input type="checkbox"/> Bei Gr.4 um 9,5 cm <input type="checkbox"/> Stück 114,- €	Abduktionsführung Code 60021 C <input type="checkbox"/> Stück 186,- €
	A	B																
Gr.1	19,5	13,5																
Gr.2	26,5	19,5																
Gr.3	32,5	29,5																
Gr.4	38	32																

Begurtungssysteme und Kopfstützen <input type="checkbox"/> Größe 0 <input type="checkbox"/> Größe 1 <input type="checkbox"/> Größe 2 <input type="checkbox"/> Größe 3 <input type="checkbox"/> Stück 186,- €	Kopfstütze Muschelform Code 60013 C <table border="1" style="width: 100%; text-align: center;"> <thead> <tr> <th></th> <th>A1</th> <th>A2</th> </tr> </thead> <tbody> <tr> <td>Gr.0</td> <td>18</td> <td>11</td> </tr> <tr> <td>Gr.1</td> <td>22</td> <td>12</td> </tr> <tr> <td>Gr.2</td> <td>28</td> <td>17</td> </tr> <tr> <td>Gr.3</td> <td>32</td> <td>21</td> </tr> </tbody> </table>		A1	A2	Gr.0	18	11	Gr.1	22	12	Gr.2	28	17	Gr.3	32	21	Abduktionskeil Code 60015 C <input type="checkbox"/> Größe 1 <input type="checkbox"/> Größe 2 <input type="checkbox"/> Größe 3 <input type="checkbox"/> Stück 166,- €	<table border="1" style="width: 100%; text-align: center;"> <thead> <tr> <th></th> <th>A1</th> <th>A2</th> <th>A3</th> </tr> </thead> <tbody> <tr> <td>Gr.1</td> <td>7</td> <td>9</td> <td>10</td> </tr> <tr> <td>Gr.2</td> <td>9</td> <td>9</td> <td>13</td> </tr> <tr> <td>Gr.3</td> <td>14</td> <td>10</td> <td>19</td> </tr> </tbody> </table>		A1	A2	A3	Gr.1	7	9	10	Gr.2	9	9	13	Gr.3	14	10	19
	A1	A2																																
Gr.0	18	11																																
Gr.1	22	12																																
Gr.2	28	17																																
Gr.3	32	21																																
	A1	A2	A3																															
Gr.1	7	9	10																															
Gr.2	9	9	13																															
Gr.3	14	10	19																															

Kopfstütze <table border="1" style="width: 100%; text-align: center;"> <thead> <tr> <th></th> <th>a</th> <th>b</th> </tr> </thead> <tbody> <tr> <td>P200L</td> <td>20cm</td> <td>10cm</td> </tr> <tr> <td>P300L</td> <td>24cm</td> <td>12cm</td> </tr> <tr> <td>P400L</td> <td>27cm</td> <td>15cm</td> </tr> </tbody> </table>		a	b	P200L	20cm	10cm	P300L	24cm	12cm	P400L	27cm	15cm	4-Punkt-Oberkörpergurt Code 60016 C (inkl. Code 60032) <input type="checkbox"/> Größe 1 <input type="checkbox"/> Größe 2 <input type="checkbox"/> Größe 3 <input type="checkbox"/> Größe 4 <input type="checkbox"/> Größe 5 <input type="checkbox"/> Stück 166,- €	Sitzhose Code 60027 C <input type="checkbox"/> Größe 1 <input type="checkbox"/> Größe 2 <input type="checkbox"/> Größe 3 <input type="checkbox"/> Stück 166,- €	<table border="1" style="width: 100%; text-align: center;"> <thead> <tr> <th></th> <th>Gr.1</th> <th>Gr.2</th> <th>Gr.3</th> </tr> </thead> <tbody> <tr> <td>a</td> <td>37 cm</td> <td>44 cm</td> <td>52 cm</td> </tr> <tr> <td>b</td> <td>15 cm</td> <td>21 cm</td> <td>26 cm</td> </tr> <tr> <td>c</td> <td>21 cm</td> <td>26 cm</td> <td>29 cm</td> </tr> </tbody> </table>		Gr.1	Gr.2	Gr.3	a	37 cm	44 cm	52 cm	b	15 cm	21 cm	26 cm	c	21 cm	26 cm	29 cm
	a	b																													
P200L	20cm	10cm																													
P300L	24cm	12cm																													
P400L	27cm	15cm																													
	Gr.1	Gr.2	Gr.3																												
a	37 cm	44 cm	52 cm																												
b	15 cm	21 cm	26 cm																												
c	21 cm	26 cm	29 cm																												

2-Punkt-Beckengurt Code 60017 C <input type="checkbox"/> Größe 1 <input type="checkbox"/> Größe 2 <input type="checkbox"/> Größe 3 <input type="checkbox"/> Größe 4 <input type="checkbox"/> Größe 5 <input type="checkbox"/> Stück 77,- €	4-Punkt-Beckengurt Code 60026 C <input type="checkbox"/> Größe 1 <input type="checkbox"/> Größe 2 <input type="checkbox"/> Größe 3 <input type="checkbox"/> Größe 4 <input type="checkbox"/> Größe 5 <input type="checkbox"/> Stück 123,- €	Gurtführung in schwarz Code 60032 <input type="checkbox"/> Paar 21,- €
--	---	---