

Kostenvoranschlag Bestellung

„Da Vinci“ Biometrisches Stehsystem

Adresse (Firmenstempel)	Patientengewicht (ca.) kg cm	Kommission:
	Patientengröße (ca.)	Besteller: Datum:

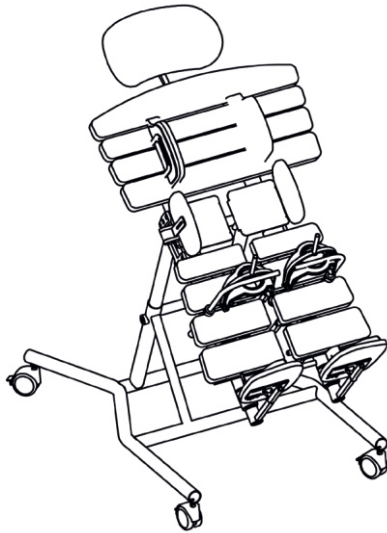

- „Da Vinci“ Biometrisches Stehsystem für Kinder und Jugendliche **Gr.1 - Typ 168** **5.072,- €**
Körpergröße: von 120 cm-155 cm
Max. Benutzergewicht: 70 kg
 Schrägverstellung elektrisch

- „Da Vinci“ Biometrisches Stehsystem für Erwachsene **Gr.2 - Typ 169** **5.796,- €**
Körpergröße: von 150 cm-180 cm
Max. Benutzergewicht: 90 kg
 Schrägverstellung elektrisch

- Akkubetrieb für „Da Vinci“** **MP 616,- €**
Code 10072

Hilfsmittelnummer: 28.29.02.1047

Farbe Gestell: Silber

- | | | |
|--------------------------|---|--------------|
| Farbe Bezug: | Fläche: | Rand: |
| <input type="checkbox"/> | Skai Dunkelrot (N 20030) + Skai Sand (N 20027) | |
| <input type="checkbox"/> | Skai Terrakotta(N 20029) + Skai Sand (N 20027) | |
| <input type="checkbox"/> | Skai Dunkelblau (N 20031) + Skai Sand (N 20027) | |
| <input type="checkbox"/> | Skai Sand (N 20027) + Skai Struktur Schwarz (N 20056) | |

Farbwunsch auf Anfrage

Grundausrüstung:

- Kopfstütze
- biometrische Rückenanlage
- Leibchen
- Beckenpelotten
- geteilte biometrische Beinauflage
- Kniepelotten (anatomisch)
- geteilte Fußplatten
- Schrägverstellung
- Grundgestell mit Transportrollen

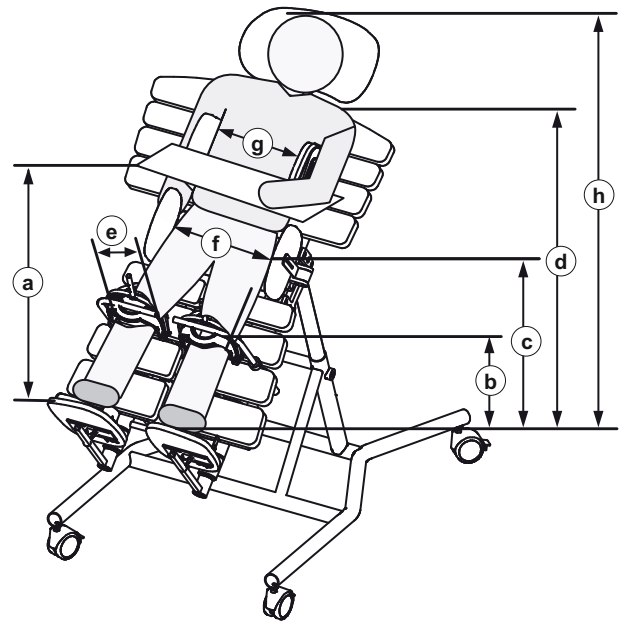

Gr.	Maß a Tischhöhe	Maß b Kniehöhe	Maß c Höhe Beckenmitte	Maß d Schulterhöhe	Maß e Kniebreite	Maß f Beckenbreite	Maß g Brustbreite	Maß h Körpergröße
1	120cm	60cm	60cm - 80cm	110cm - 130cm	8cm - 13cm	25cm - 40cm	25cm - 41cm	120cm -155cm
2	120cm	60cm	80cm - 95cm	140cm - 170cm	8cm - 13cm	25cm - 40cm	25cm - 41cm	150cm -180cm

Patientenmaße:

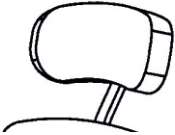
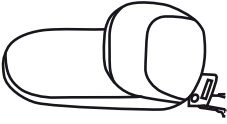
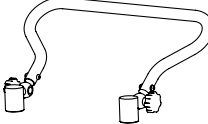
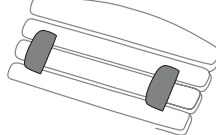

--	--	--	--	--	--	--	--

„Da Vinci“ Biometrisches Stehsystem

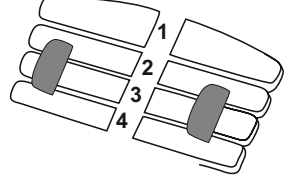
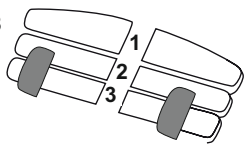
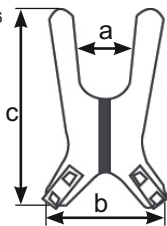
Kopfstütze Muschelform Code 10067 	Verstellbare Kopfstütze Code 10075 <input type="checkbox"/> Gr. 1 <input type="checkbox"/> Gr. 2  <table border="1"> <tr><th>Gr.1</th><th>Gr.2</th></tr> <tr><td>gestreckte Länge</td><td>42 cm / 51 cm</td></tr> <tr><td>Höhe</td><td>10 cm / 14 cm</td></tr> </table>	Gr.1	Gr.2	gestreckte Länge	42 cm / 51 cm	Höhe	10 cm / 14 cm	Schiebebogen Code 1011171 	Seitenführungspelotte, abklappbar Code 10062 
Gr.1	Gr.2								
gestreckte Länge	42 cm / 51 cm								
Höhe	10 cm / 14 cm								
STANDARD	<input type="checkbox"/> Stück MP 124,- €	<input type="checkbox"/> Stück 259,- €	<input type="checkbox"/> Paar 196,- €						

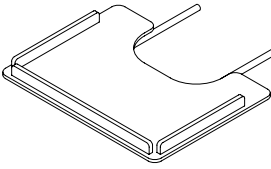
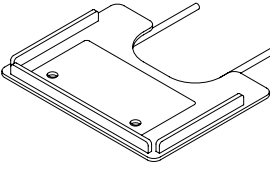
Geteilter Rücken Code 1009756 für Typ 169 <input type="checkbox"/> 1 <input type="checkbox"/> 2 <input type="checkbox"/> 3 <input type="checkbox"/> 4 	für Typ 168 <input type="checkbox"/> 1 <input type="checkbox"/> 2 <input type="checkbox"/> 3 	Leibchen Code 10066 Damen <input type="checkbox"/> Gr. 2 <input type="checkbox"/> Gr. 3 <table border="1"> <tr><th>Gr.2 (D)</th><th>Gr.3 (D)</th></tr> <tr><td>a</td><td>13 cm / 15 cm</td></tr> <tr><td>b</td><td>12 cm / 20 cm</td></tr> <tr><td>c</td><td>40 cm / 49 cm</td></tr> </table>	Gr.2 (D)	Gr.3 (D)	a	13 cm / 15 cm	b	12 cm / 20 cm	c	40 cm / 49 cm	Herren <input type="checkbox"/> Gr. 2 <input type="checkbox"/> Gr. 3 <table border="1"> <tr><th>Gr.2 (D)</th><th>Gr.3 (D)</th></tr> <tr><td>a</td><td>12 cm / 18 cm</td></tr> <tr><td>b</td><td>16 cm / 22 cm</td></tr> <tr><td>c</td><td>40 cm / 46 cm</td></tr> </table> 	Gr.2 (D)	Gr.3 (D)	a	12 cm / 18 cm	b	16 cm / 22 cm	c	40 cm / 46 cm
Gr.2 (D)	Gr.3 (D)																		
a	13 cm / 15 cm																		
b	12 cm / 20 cm																		
c	40 cm / 49 cm																		
Gr.2 (D)	Gr.3 (D)																		
a	12 cm / 18 cm																		
b	16 cm / 22 cm																		
c	40 cm / 46 cm																		
<input type="checkbox"/> MP je Position/Element	259,- €	STANDARD																	

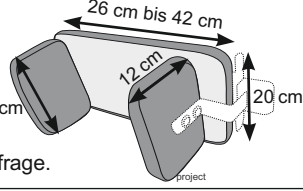
Therapietisch tiefen und winkelverstellbar, inkl. Tischumrandung Code 10061 	Therapietisch mit Therapiemulde tiefen und winkelverstellbar, inkl. Tischumrandung Code 1010528 	Spinenpelotten (Retraktionsbügel) Code 10063 <input type="checkbox"/> Gr. 1 (a = 13,5 cm - 19,5 cm) <input type="checkbox"/> Gr. 2 (a = 19,5 cm - 26,5 cm) <input type="checkbox"/> Gr. 3 (a = 29,5 cm - 32,5 cm) <input type="checkbox"/> Gr. 4 (a = 38 cm - 32 cm) 
<input type="checkbox"/> Stück 673,- €	<input type="checkbox"/> Stück 921,- €	<input type="checkbox"/> Stück 202,- €

Pelvi.Loc-Beckengurt Code 10070 <input type="checkbox"/> Gr. XS=Gr. S mit verkürzten Pelotten) <input type="checkbox"/> Gr. S (20 - 32 cm) <input type="checkbox"/> Gr. M (28 - 38 cm) <input type="checkbox"/> Gr. L (36 - 46 cm) 	Beckenplatte mit abschwenkbaren Seitenpelotten Code 1010994  <p>26 cm bis 42 cm 12 cm 20 cm 20 cm</p> <p>Größere Maße auf Anfrage.</p>	Kniepelotten, anatomisch Code 10064 <input type="checkbox"/> 8 cm <input type="checkbox"/> 11,5 cm <input type="checkbox"/> 13 cm 
<input type="checkbox"/> Stück 259,- €	Paar/MP 259,- €	<input type="checkbox"/> Stück 202,- €

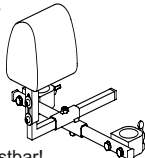
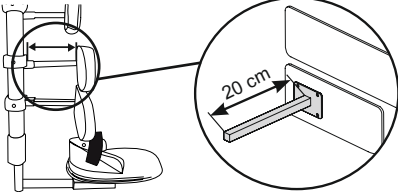
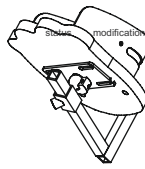
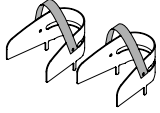
Abduktionskeil Code 1000237  <p>Nicht nachrüstbar! Nur bei Neugeräten!</p>	Verlängerung mittlerer Beinauflage Code 10071  <p>20 cm</p>	Spitzfußkorrektur Code 10068 	Fußschalen inkl. Fußriemen Code 10069  <p>Beckenbügel</p>
<input type="checkbox"/> Stück 347,- €	<input type="checkbox"/> PaarMP 83,- €	<input type="checkbox"/> PaarMP 231,- €	<input type="checkbox"/> PaarMP 152,- €

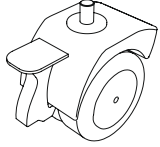
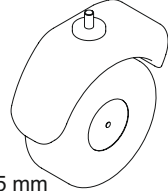
Transportrollen Bitte wählen! 			
<input type="checkbox"/> 75 mm	<input type="checkbox"/> 125 mm		
STANDARD			